



**Inspection of
HVAC systems
through
continuous
monitoring and
benchmarking**

www.iservcmb.info



Benchmarking HVAC system energy performance – an overview of the European iSERV project

**Dr Ian Knight - iSERV Coordinator
Dr Zoltan Magyar – iSERV Hungary
Dr Vincenc Butala – iSERV Slovenia**

www.iservcmb.info

The sole responsibility for the content of this presentation lies with the authors. It does not necessarily reflect the opinion of the European Union. Neither the EACI nor the European Commission are responsible for any use that may be made of the information contained here.

iSERVcmb – the continuous monitoring and benchmarking of HVAC systems



- www.iservcmb.info May 2011 – May 2014
- At €3.3M iSERVcmb is the largest EC project ever funded under the IEE funding stream
- iSERV builds on AUDITAC (2005 – 2007) and HARMONAC (2007 – 2010) www.harmonac.info
- Until recently HARMONAC was also the second largest project ever funded under the IEE stream at €1.8M
- The projects are high-profile within the EC and will help inform future policy in this area

iSERV Partners and Steering Group



<p>Welsh School of Architecture, Cardiff University Building energy use experts</p>		<p>K2n Ltd Energy database experts</p>	
<p>MacWhirter Ltd Installation, Maintenance and Energy Inspections</p>		<p>National and Kapodistrian University of Athens Indoor Air Quality experts</p>	
<p>University of Porto HVAC and Engineering experts</p>		<p>Politecnico di Torino HVAC and Engineering experts</p>	
<p>Université de Liège HVAC and Modelling experts</p>		<p>Univerza v Ljubljani HVAC and Engineering experts</p>	
<p>University of Pecs HVAC and Engineering experts</p>		<p>Austrian Energy Agency Dissemination and Legislation</p>	
<p>REHVA HVAC Professional Body</p>		<p>CIBSE HVAC Professional Body</p>	
<p>SKANSKA Building Developer</p>		<p>Camfil Farr Filter manufacturer</p>	
<p>SWEGON AHU System manufacturer</p>			

Why are we interested in the energy use of HVAC systems?



Equipment	Electrical consumption as % of total EU 2007 Elec use
Air conditioning units and chillers	0.75
Fans in ventilation systems	3.34
Pumps / circulators	1.81
Space and Hot Water Heating	5.23
TOTAL	11.13%

EC Joint Research Centre, Institute for Energy, 2009

- At this level of energy consumption, HVAC systems must be a key contributor towards energy savings in the EU
- EU GDP in 2007 ~ €13,500Bn. Electricity costs were ~ €650 – 1,950Bn or 5 – 15% of GDP. Fossil fuel costs are on top of this.

Understanding energy use in buildings – UK experience



- ➔ 1970's – 1990's: Limited, expensive measuring trials – needed to install monitoring equipment. Gave confidence that numbers were correct but lacked scale to understand whole buildings normally
- ➔ 1990's – 2000: Rapid growth of computing power and validation of computing software by the modelling community meant large scale physical data collection became very rare by the end of the 1990's. Data from early 1990's still dominates a lot of energy benchmarking
- ➔ 2002 onwards: EPBD and Part L requires sub-metering of new build and Display Energy Certificates – stimulates market for metering and data collection companies
- ➔ Present day: Lots of cost-effective metering and data collection solutions now exist and there is a move back towards using real data for performance validation and informing modelling. Reinforced by lots of new buildings not performing to their modelled predictions.

Buildings are for activities



- ➔ We construct environments (buildings) in which to undertake activities. Energy use is a direct effect of these activities.
- ➔ Energy efficiency is therefore always bound by the requirements of these activities. Providing the wrong environment needed for the activities is counterproductive to the wider needs of the organisation
- ➔ Energy efficiency can therefore only be properly evaluated when put into the context of the activities served

What we need to know is:

‘How much energy is it appropriate to use for a given activity?’

HVAC energy efficiency - practice



→ A sub-question to the previous question, when trying to run the services in a building in an energy efficient manner, is:

‘Is the energy being consumed by an HVAC system reasonable for the activities it serves?’

→ Asking the question is easy – providing a convincing answer is more difficult

HARMONAC: 2007 - 2010



- An IEE European project, which obtained sub-hourly information on energy use in HVAC systems from 42 EU Systems
- It showed the electrical energy use of HVAC systems is typically 30 – 40% of the building total electrical use.
- HVAC generally accounts for > 90% of non-electrical energy use
- Produced data on in-use energy consumption in HVAC components
- All findings at: www.harmonac.info

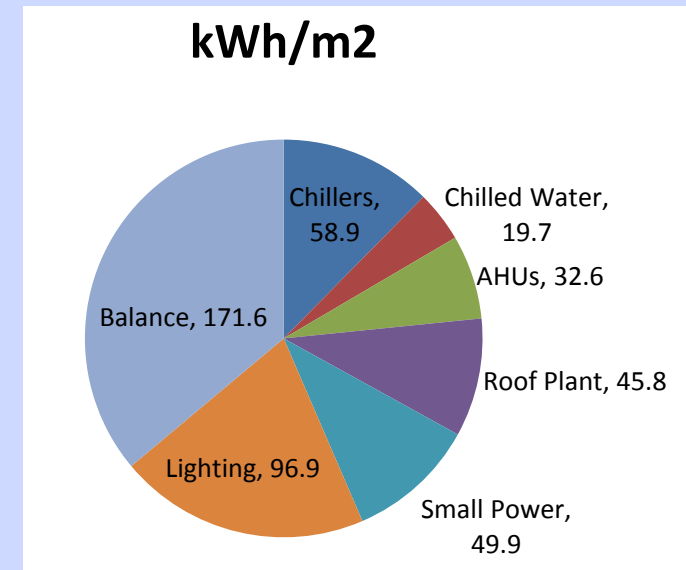

Annual energy balance – One Wood Street, London

What does iSERVcmb do?



→ iSERVcmb has 5 main aims:

- Show how an automatic energy monitoring and feedback system based on physical assets might look like in reality in the EU-27
- Show the in-use energy savings being achieved in real buildings from implementation of such a system from data collected across the EU-27
- Provide guidance to the EU – 27 Member State policymakers about how to write legislation for such systems
- Provide benchmark ranges for the achieved energy performance of HVAC components in practice when servicing stated end-use activities
- Produce measurement based guidance to the professions on how to reduce the in-use energy consumption of HVAC systems in buildings

Barriers to reducing energy use



- ➔ Lack of meaningful benchmarks with which to compare achieved consumption for the specific existing situation
- ➔ Missing detailed information on the specifics of the building, its activities and systems
- ➔ Lack of current exemplars to show efficiency achieved in the context of real operations
- ➔ Lack of expertise in interpreting data
- ➔ Perception that savings are not worth the manpower costs

Support for reducing energy use



- ➔ Currently, energy savings can give some of the best returns on investment available. Paybacks in less than a month are commonplace.
- ➔ Lack of money is NOT generally an issue in this market
- ➔ Legislative drivers are underpinning a drive towards reduced energy use
- ➔ Increasing pressure on generation and distribution capacity making new connections increasingly expensive

Aren't we designing buildings well anyway?



- Two London, UK HQ Office buildings monitored in HARMONAC were very close in terms of occupancy type and activities.
- One was new at the start of monitoring and used the very latest 'advice' on trying to achieve a low energy design (variable speed drives, low fresh air rates, chilled beams, low energy daylight linked lighting, etc)
- The other was a 1988 building with that era plant which was gradually being updated.
- They both used a nearly identical amount of HVAC energy per m².
- **Even the 'experts' don't fully understand the implications of their design decisions on achieved 'in-use' energy performance**
- The benefits of 'energy efficient' HVAC **components** can potentially be negated by poor design and operating decisions.
- **Poor design choices can be locked into HVAC system energy performance for decades**

Managing energy use in buildings



Confidence

Targeted Feedback

Targeted Advice

Confidence...



- ➔ ...that the benchmarks and advice apply to the specific situation and are achievable in reality
- ➔ ...in practice is achieved from real up-to-date data from comparable real situations:
 - Real data on specific systems >> modelled data on generic systems in persuading owners to act
 - Information that the owner/operator can physically relate to their situation is also persuasive in achieving both investment and desired outcomes
 - 'Before' and 'after' investment performance data is crucial to showing achieved savings, leading to greater confidence in the decision making process and further investment

Feedback...



- ➔ ... specific to the existing situation is vital to provide confidence that the investment has achieved the desired effect, and to identify further opportunities and issues that need addressing.
- ➔ ... is also needed for the controllers of the energy consumption in the building. Studies have shown that involving the occupants in reducing the consumption of the energy they control can reduce overall energy use by up to 30%
- ➔ ... is vital to maintaining achieved savings

Advice...



- ➔ ... is often required on the more subtle aspects of understanding the data presented. Usually the recipients are not data analysis experts and therefore the energy conservation opportunities sometimes need clarification.
- ➔ ... linked to specific real energy consumption patterns and costs is very persuasive in achieving action
- ➔ ...from independent sources is important to remove suspicion of salesman's bias

- Inspection of services through continuous monitoring and benchmarking
- Runs May 2011 to May 2014
- Follows on from HARMONAC (2007 to 2010) which led to a change in the European Energy Performance of Buildings Directive (EPBD) in 2010 to allow Member States to use automatic monitoring and feedback as an alternative to physical inspections of Heating, Ventilation and Air Conditioning (HVAC) Systems.
- iSERVcmb demonstrates how such an alternative approach might work and will provide **measured benchmarks of HVAC component energy use** when serving specified end use activities and areas.

iSERVcmb - rationale



- ➔ Collation of the measured **ranges** of consumption by HVAC system components in real buildings serving specified activities. Around 7,500 benchmark types are expected with 75,000 data points.
- ➔ The data collected from around the 27 EU Member States will also act as a basis for further studies looking at the common factors present in low and high energy use buildings.
- ➔ The building design is treated as an energy conservation opportunity i.e. the project does not define the building in terms of anything other than spaces and activities provided.
- ➔ The data profiles from the HVAC system components will show the gross effects of building design or location issues with systems as currently operated.

Buildings and sectors



- ➔ A building's energy use is more influenced by the spaces and activities it contains, not the sector to which it belongs i.e. one hospital is not necessarily comparable with another hospital.
- ➔ iSERV defines each building in terms of its HVAC components, meters, areas and activities.
- ➔ From the use of the iSERVcmb **benchmarks by HVAC component vs activity serviced**, each building therefore gets its own unique benchmark energy consumption ranges based on its specific mixture of HVAC components, activities and areas
- ➔ This allows buildings containing energy intensive activities to still obtain sensible benchmarks for performance by comparison with buildings containing similar end use activities
- ➔ This information and insight is important for establishing practical legislation and ground rules for setting in-use performance targets

Accounting for Energy Use - Assigning Responsibility



→ Building energy use splits logically into two areas:

- The **energy use consumed and required by the occupants** of the building when undertaking the activities for which the building is operated
- The **consequent energy use of these activities** i.e. energy consumed by the services to provide the conditions required for the activities.

→ Practically we therefore need to assess the energy use in buildings from these two viewpoints

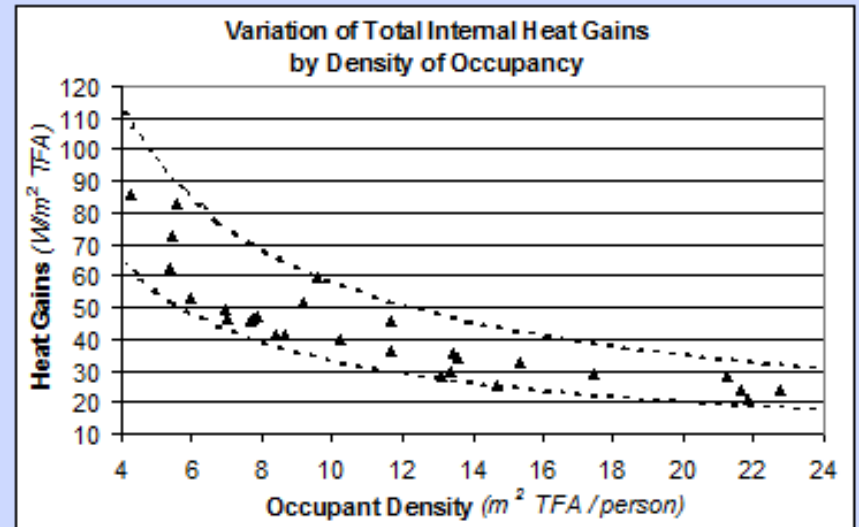

Role of the occupant



- ➔ A number of studies have shown that engaging end users can achieve significant savings (up to 30%) in electricity use.
- ➔ Any good energy management system must therefore provide **Responsibility and Accountability** for energy use, along with ongoing **Engagement** of the people responsible for this use.
- ➔ ISO 50001:2011 provides further guidance on the structure required for Energy Management Systems

Anticipated iSERVcmb project impacts



- CIBSE and REHVA to use this information to produce professional guidance – thus allowing EU Member State legislators to refer to it
- Establish iSERVcmb approach as a complement to Inspection
- **Electricity savings between 5 – 60% per system anticipated**
- **Electricity savings of between 5 – 15% on average**
- **Unquantified heating savings (5 – 20% anticipated)**
- Savings expected to be maintained c.f. Inspection reductions
- Provide end users with HVAC system specific ECOs

iSERV basics



- ➔ iSERV directly addresses the confidence, feedback and advice requirements identified earlier by providing a practical framework for describing a building by its spaces, activities and services
- ➔ It does this by collating physical information on these assets in a way that is rarely, if ever, done for HVAC systems at present:
 - It catalogues the HVAC components, meters and sensors
 - It describes the spaces, areas and activities served by the HVAC systems
 - It links all these elements together to describe the HVAC system components in terms of areas and activities served
 - It provides a web-based system to collate and report on all this information, and to receive sub-hourly metered data to evaluate the HVAC systems' on-going performance.
- ➔ By collecting data from a significant number of systems from around Europe, iSERV can produce statistically robust benchmark ranges of achieved energy performance at HVAC component level for a given end-use activity

iSERV data entry sheet



- ➔ Part of the iSERV Excel-based data entry sheet is shown below
- ➔ The sheet is endorsed by CIBSE and REHVA as an accepted means of recording information about HVAC systems

Data applies from this date (dd/mm/yyyy):			Validate					
Building								
Building Name*	Description	Organisation Name*	Site Name*	Sector*	Address*	Town*	Postcode*	Country*
				<Ctrl-↓>				<Ctrl-↓>
Utility Meter							Add a Meter	
Name*	Description	Meter Type*	Unit Type*	Multiplier	Space Where Located	Unique Meter Id*	Parent Meter Name	
		<Ctrl-↓>	<Ctrl-↓>				<Ctrl-↓>	
HVAC Sensor							Add a Sensor	
Name*	Description	Sensor Type*	Unit Type*	Duct/Pipe Area m2	Unique Sensor Id*			
		<Ctrl-↓>	<Ctrl-↓>					
HVAC System							Add a HVAC System	
Name*	Description	Main HVAC System*	HVAC Type*	System Classification*	System Sub-classification*	Sensor Name(s)	Meter Name(s)	Control Of Flow Temperature
		<Ctrl-↓>	<Ctrl-↓>	<Ctrl-↓>	<Ctrl-↓>	None	None	<Ctrl-↓>
HVAC Component							Add a HVAC Component	
Name*	Description	Component Type*	Component Sub-type*	Serves which HVAC System(s)*	Space Where Located	Nominal Electrical Power Input (KW)	Meter Name(s)	Sensor Name(s)
		Pumps	<Ctrl-↓>	<Ctrl-↓>			<Ctrl-↓>	<Ctrl-↓>
Schedules of Setpoint and Occupation							Add a Schedule	
To configure the schedule details please enter dates into the applies from or applies to cells below and then double click - this will take you to the schedule on the schedules tab								
Name*	Description	Range 1 - Applies From*	Range 1 - Applies To*	Range 2 - Applies From	Range 2 - Applies To	Range 3 - Applies From	Range 3 - Applies To	Range 4 - Applies From
Schedule 1 - Whole Building		01/01/2012	31/12/2012					
Space							Add a Space	
Name*	Description	Floor Area (m2)*	Height (m)	Sector*	Activity*	Served By HVAC(s)	Utility Meter(s)	Schedule of Setpoints, RH and Occupancy
				<Ctrl-↓>	<Ctrl-↓>	<Ctrl-↓>	<Ctrl-↓>	Schedule 1 - Whole Building

Overview of basic process

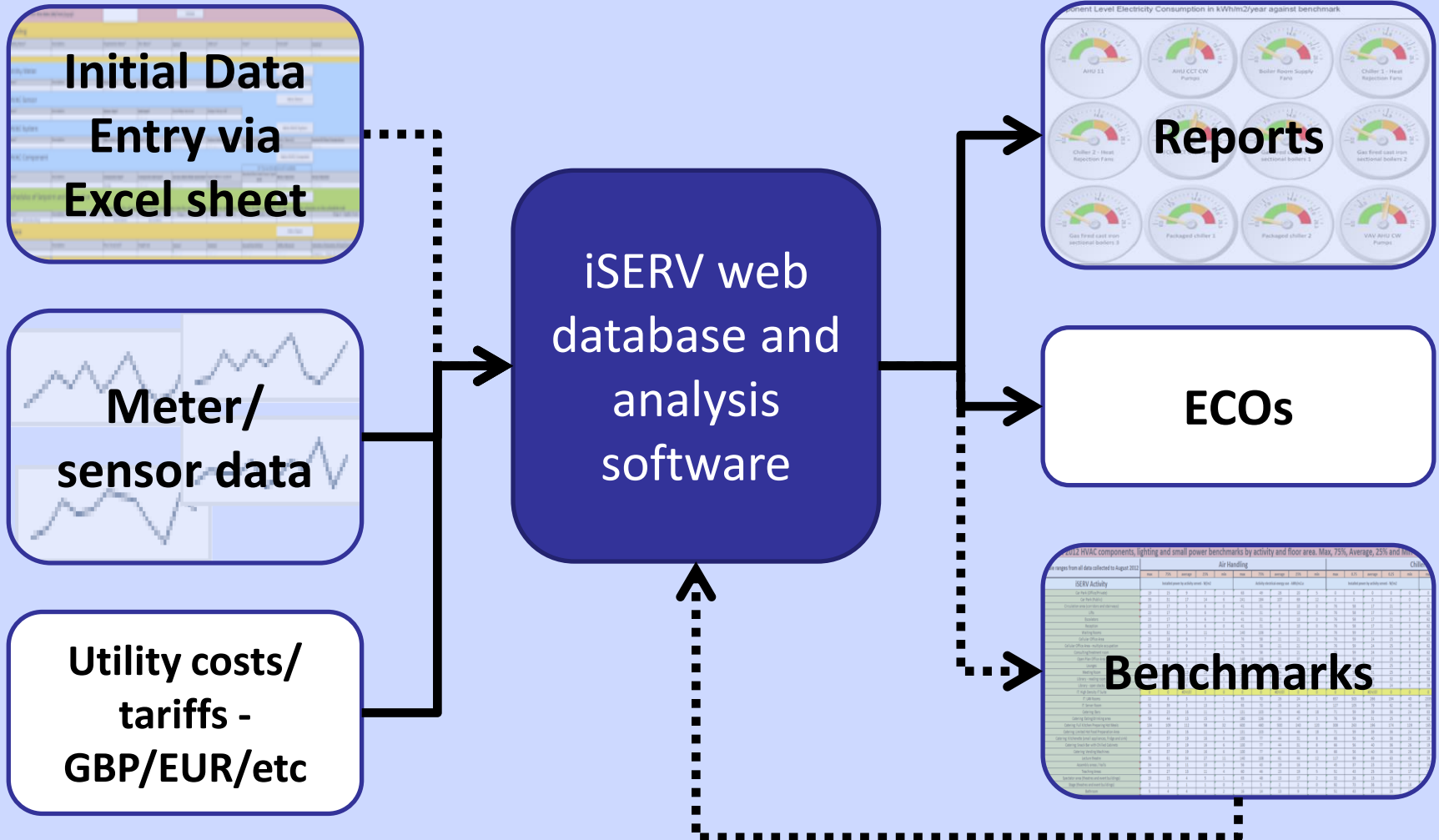

iSERV Asset Definition



Describe the building utility meters, including their physical locations

Describe the building spaces and the main activity that occurs in them

Incoming Meter

Meter 1

Meter 2

Meter 3

Meter 4

Meter 5

Chillers

CHW pumps

HW pumps

AHU 1

AHU 2

Boilers

Describe the building HVAC components, including their physical locations

Room 1

Room 2

Room 3

Room 4

Room 5

iSERV Asset Integration



The meters, spaces and HVAC systems are now described and connected
Connect the meters to the HVAC components and spaces they serve
Connect the HVAC components to the systems they serve
Connect the HVAC systems to the spaces they serve

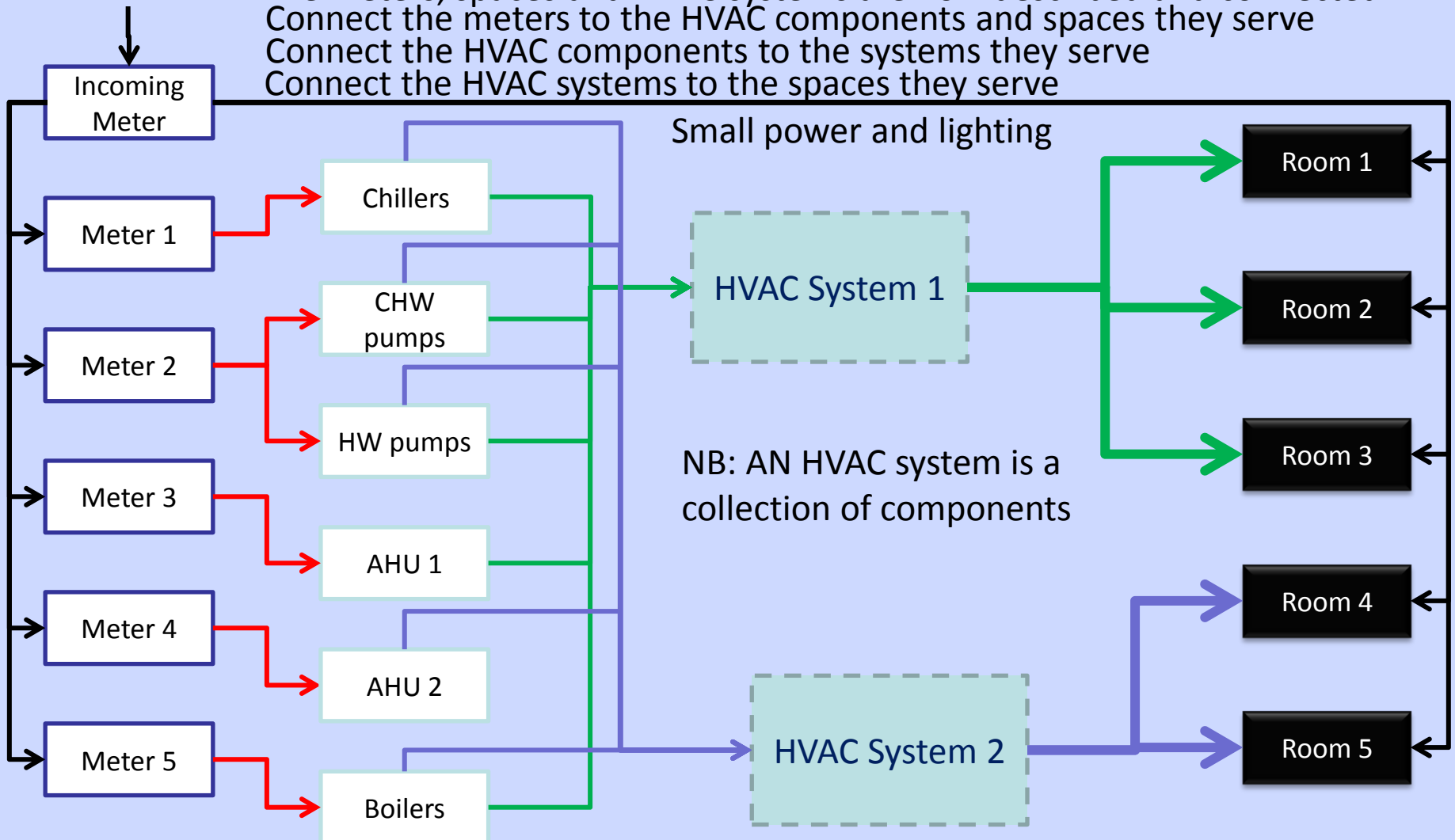

Meters, Sensors and Reports



- ➔ It is important to remember that iSERV primarily wishes to establish ranges of energy consumption by HVAC component type when serving a specified end-use activity
- ➔ However, users of the system can provide more information about the spaces and components e.g. Air temperatures, RH's, CO₂ levels, fluid temperatures, flow rates, etc
- ➔ The level of detail of the reports provided back to the end user increases with the amount of information provided to the database

iSERV Asset Reporting

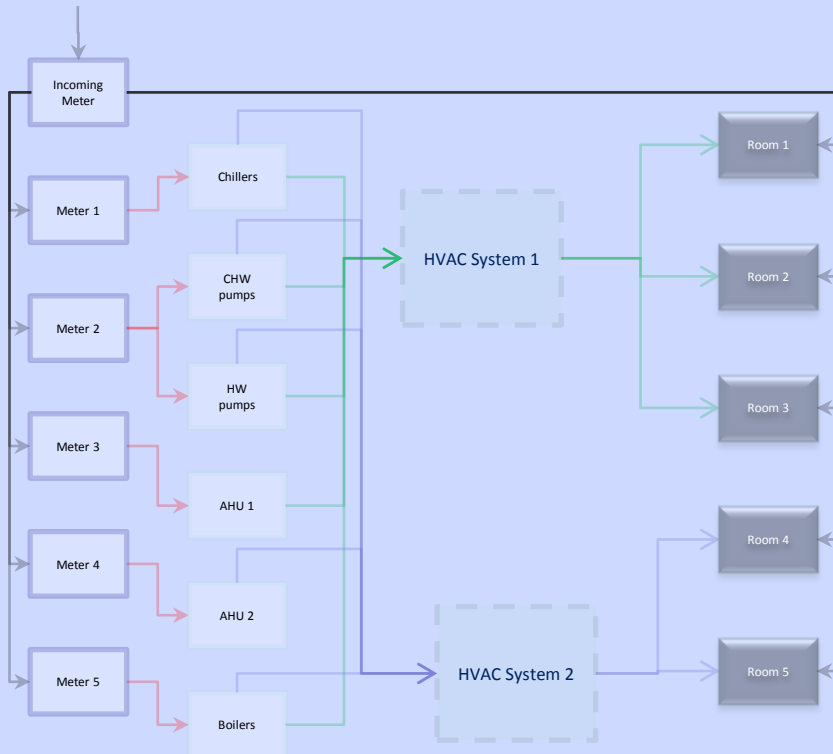

- The collected data can be reported back to the data provider in a variety of ways. We can produce reports at the level of individual assets, groups of assets, or the building as a whole
- The depth of reporting depends on the information initially provided
- All reports require the Assets to have been described and integrated in the initial data entry spreadsheet, and a minimum of the main incoming meter data
- The iSERV project also requires **at least** the Chiller(s) consumptions to be monitored sub-hourly

iSERV Asset Reporting – Minimum data

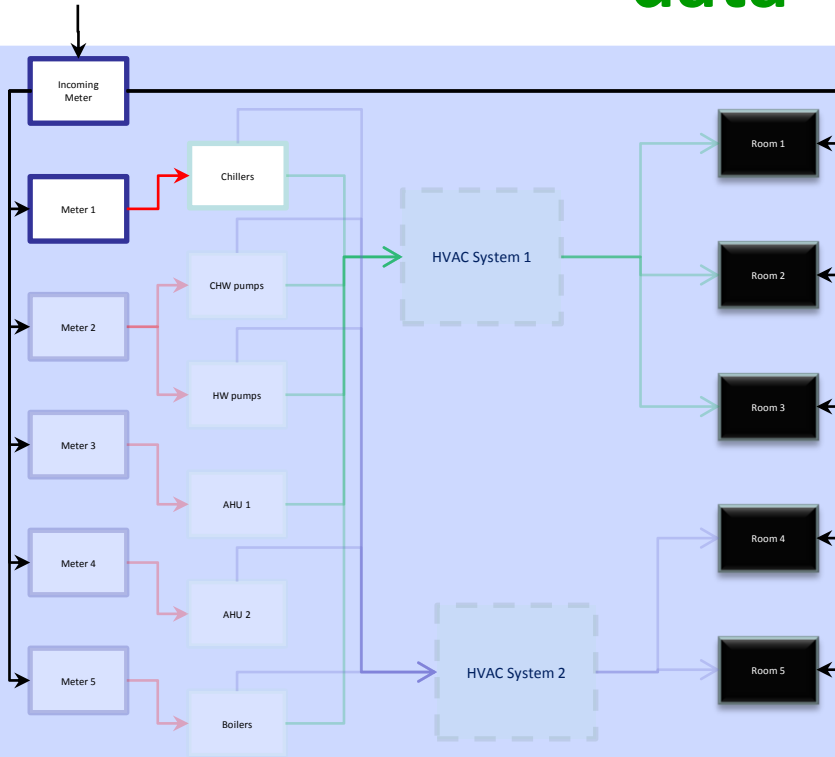

- Where the main meter only is reported then reports are limited to estimates of where the measured overall energy use is going, based on the benchmarks for the HVAC components, areas and activities
- This is useful for determining where to install submeters to verify the main data flows, but is not ideal as the basis for changing HVAC plant components or for verifying the savings achieved
- At least the Chillers (if present) should be monitored to participate in iSERV

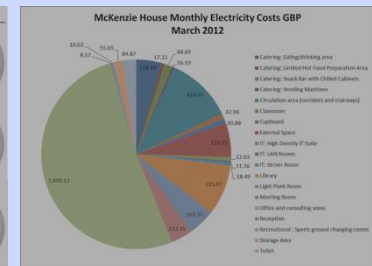
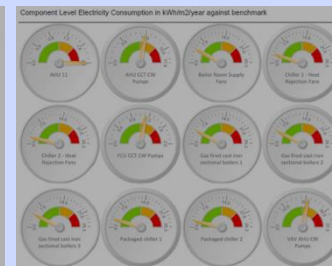
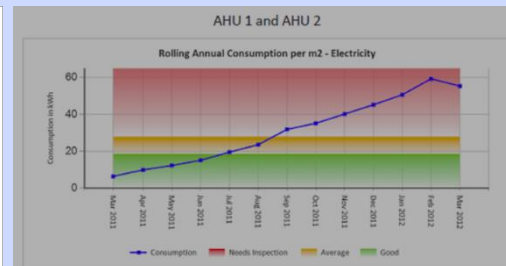
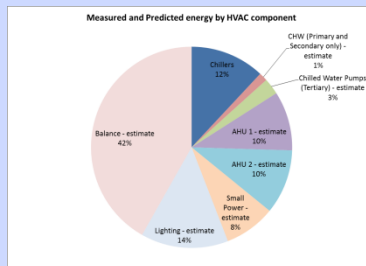

iSERV Asset Reporting – full metering

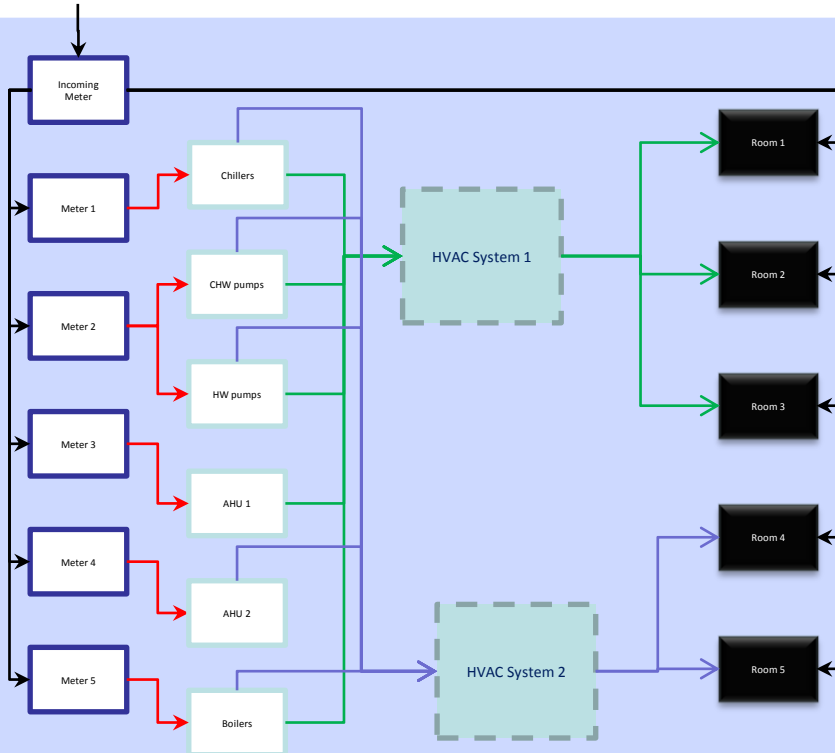

- Where everything is metered then we can produce a full set of reports including energy use by HVAC component, space, activity – along with any relevant ECOs and cost information where tariff information is provided
- This information can not only provide certainty about day-to-day operation but also about which areas to target for the best long-term investment returns from energy efficiency

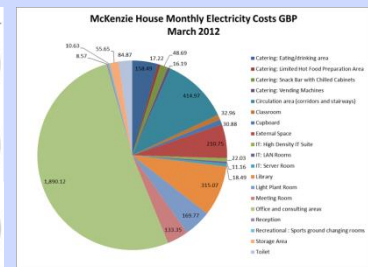
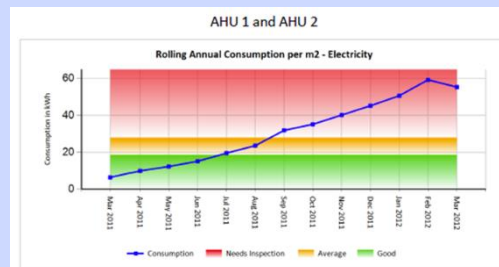
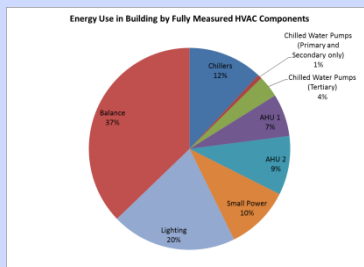

Making sense of the data



➔ iSERV will process the information provided to the database by individual systems to produce the required confidence, feedback and 'advice' for an owner/operator to make decisions on their specific system:

- Bespoke benchmarks per HVAC component and system
- Clear reports – including benchmark and exception reports
- Suggestions for Energy Conservation Opportunities (ECOs)

➔ From analysing the data for the 1600+ HVAC systems iSERV will also:

- Note what 'works' in practice – technology neutral
- Produce on-going benchmarks over time for use in legislation and professional guidance
- Update and add to the ECOs

The transition to nZEB



- ➔ The reality check of what it is actually possible to achieve in operational buildings is also important for an orderly transition to nZEB by 2019 and 2021, as clearly some activities cannot be zero energy by their nature.
- ➔ It is important we do not have inappropriate legislation for meeting 'nZEB' status that does not recognise these issues, otherwise the legislation becomes impossible to implement as many buildings will be unable to meet inappropriate targets.

Practical benchmarks



- ➔ Legislative drivers and signals are important in affecting energy use in practice as they require compliance.
- ➔ What we struggle with at present is providing practical, 'legislation friendly' benchmarks for the energy efficiency possible in buildings **with a specific mix of end use activities**
- ➔ Discussions are underway with the EU-27 Member State legislators on how iSERV's data derived benchmarks might contribute to forthcoming legislation

Initial HVAC components, lighting and small power benchmarks



- ➔ An initial set of ~7,500 installed power and annual energy use/m² benchmarks by activity for AHU's, Chillers, CHW, HW and DHW Pumps, Heat Rejection, Humidifiers, Boilers, Lighting and Small Power has been assembled from existing data.
- ➔ This data is used to produce the first indicative bespoke benchmark ranges for those buildings and HVAC systems supplying data to iSERV

Component Type	Component Sub-Type	Activity	Benchmark Re	Installed power by activity served - W/m2					Activity electrical-energy use - kWh/m2.a				
				max	0.75	average	0.25	min	max	0.75	average	0.25	min
Air Handling Units	Supply and extract	Multi-storey car parks (office and private use)	y	19	15	9	7	3	63	49	28	20	5
Air Handling Units	Supply and extract	Multi-storey car parks (public use)	y	39	31	17	14	6	241	184	107	69	12
Air Handling Units	Supply and extract	Circulation area (corridors and stairways)	y	23	17	5	6	0	41	31	8	10	0
Air Handling Units	Supply and extract	Lifts	y	23	17	5	6	0	41	31	8	10	0
Air Handling Units	Supply and extract	Escalators	y	23	17	5	6	0	41	31	8	10	0
Air Handling Units	Supply and extract	Reception	y	23	17	5	6	0	41	31	8	10	0
Air Handling Units	Supply and extract	Waiting Rooms	y	42	32	9	11	1	140	106	24	37	3
Air Handling Units	Supply and extract	Cellular Office Area	y	23	18	9	7	1	76	58	21	21	3
Air Handling Units	Supply and extract	Cellular Office Area - multiple occupation	y	23	18	9	7	1	76	58	21	21	3
Air Handling Units	Supply and extract	Consulting/treatment room	y	23	18	9	7	1	76	58	21	21	3
Air Handling Units	Supply and extract	Open Plan Office Area	y	42	32	9	11	1	140	106	24	37	3
Air Handling Units	Supply and extract	Lounges	y	42	32	9	11	1	140	106	24	37	3
Air Handling Units	Supply and extract	Meeting Room	y	58	44	13	15	1	180	136	34	47	3
Air Handling Units	Supply and extract	Library - reading room	y	65	50	13	18	3	270	204	49	72	6
Air Handling Units	Supply and extract	Library - open stacks	y	18	14	6	5	1	69	52	21	19	2
Air Handling Units	Supply and extract	IT: High Density IT Suite	y	65	50	18	18	3	270	204	76	72	6
Air Handling Units	Supply and extract	IT: LAN Rooms	y	11	8	3	3	1	93	70	26	24	1
Air Handling Units	Supply and extract	IT: Server Room	y	113	85	3	29	1	93	70	26	24	1
Air Handling Units	Supply and extract	Catering: Bars	y	29	23	16	11	5	131	103	73	46	18
Air Handling Units	Supply and extract	Catering: Eating/drinking area	y	58	44	13	15	1	180	136	34	47	3
Air Handling Units	Supply and extract	Catering: Full Kitchen Preparing Hot Meals	y	134	109	112	58	32	600	480	500	240	120
Air Handling Units	Supply and extract	Catering: Limited Hot Food Preparation Area	y	29	23	16	11	5	131	103	73	46	18
Air Handling Units	Supply and extract	Catering: Kitchenette (small appliances, fridge and sink)	y	47	37	19	16	6	100	77	44	31	8
Air Handling Units	Supply and extract	Catering: Snack Bar with Chilled Cabinets	y	47	37	19	16	6	100	77	44	31	8
Air Handling Units	Supply and extract	Catering: Vending Machines	y	47	37	19	16	6	100	77	44	31	8
Air Handling Units	Supply and extract	Lecture theatre	y	78	61	34	27	11	140	108	61	44	12
Air Handling Units	Supply and extract	Assembly areas / halls	y	34	26	11	10	3	56	43	19	16	3
Air Handling Units	Supply and extract	Teaching Areas	y	35	27	13	11	4	60	46	23	19	5
Air Handling Units	Supply and extract	Spectator area (theatres and event buildings)	y	19	15	4	5	1	63	48	13	17	2
Air Handling Units	Supply and extract	Stage (theatres and event buildings)	y	3	2	1	1	0	7	5	2	2	0
Air Handling Units	Supply and extract	Bathroom	y	5	4	4	3	2	16	14	13	9	7
Air Handling Units	Supply and extract	Toilet	y	5	4	4	3	2	16	14	13	9	7
Air Handling Units	Supply and extract	Bedroom	y	25	19	11	9	4	210	165	90	76	31
Air Handling Units	Supply and extract	Laboratory	y	71	54	28	21	5	155	121	65	53	18
Air Handling Units	Supply and extract	Laboratory with fume cupboards	y	71	54	28	21	5	155	121	65	53	18
Air Handling Units	Supply and extract	Laboratory - Sterile	y	71	54	28	21	5	155	121	65	53	18

Makeup of a benchmark for an activity



- The graphs show **measured** ranges of installed capacity and energy use **per m²** for AHU's used in cellular offices in multiple occupation
- By adding together all the components of an HVAC system serving an activity and area in a specific building, we can assemble an overall HVAC benchmark for a space or collection of spaces

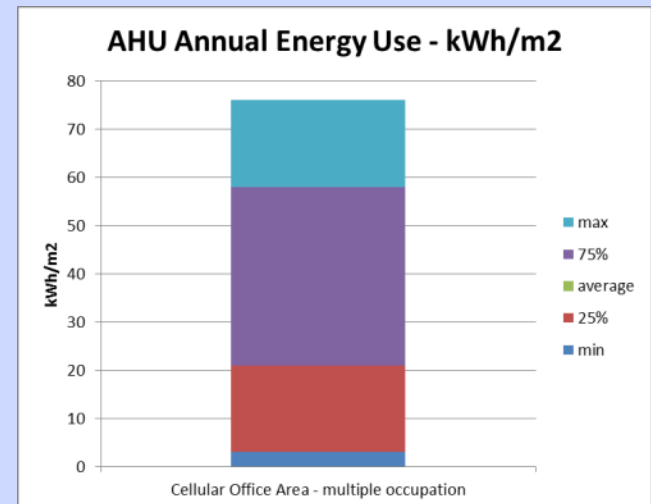
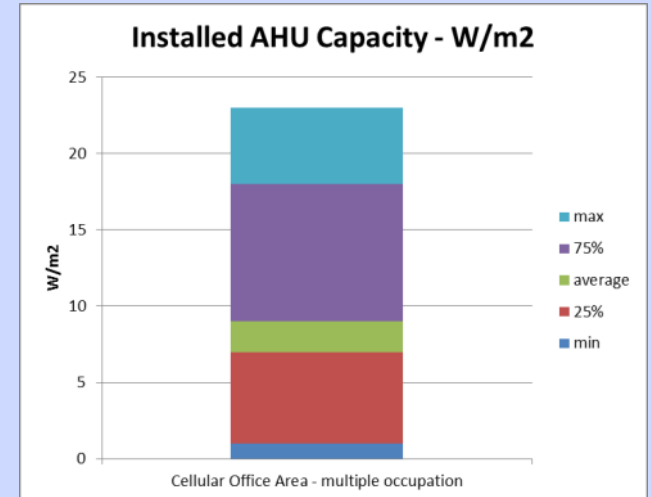

iSERV benchmark types



- ➔ It is intended to produce ranges of benchmarks by activity at the levels of:
 - Annual energy consumption per m^2 ($kWh/m^2.a$)
 - Monthly energy consumption per m^2 ($kWh/m^2.month$)
 - Peak and average power consumptions in use (W/m^2)
- ➔ Initially, range boundary figures for the upper and lower quartiles of the measured data will represent the boundaries between 'good': 'average' and 'average': 'needs inspection' energy performance

Energy Conservation Opportunity (ECO) Reports



- ➔ Another unique feature of iSERV is its ability to take the measured data for the HVAC components along with other characteristics of the HVAC components and spaces, and suggest potential ECOs that could reduce the energy use of the specific HVAC system.
- ➔ iSERV can provide an indication of the likely energy, carbon and cost savings to be achieved for each ECO where the required information is provided by the end user.
- ➔ ECO reports maximise the value of sub-meters, and help reduce the analysis time needed by the energy manager to understand his HVAC system.

Likely impacts? McKenzie House performance since occupancy



- ➔ Occupied June 2003
- ➔ Electricity reduction from peak of 195 kWh/m² in August 2005 to around 178 kWh/m² in October 2008 is considered to be primarily due to the implementation of an Eco-champions network at this time
- Further reductions to current 132 kWh/m² are due to improved control of HVAC systems during HARMONAC and iSERV
- HVAC savings ~ 23%
- Eco-champions ~ 9%
- ~£74,000/a elec savings
- More to come

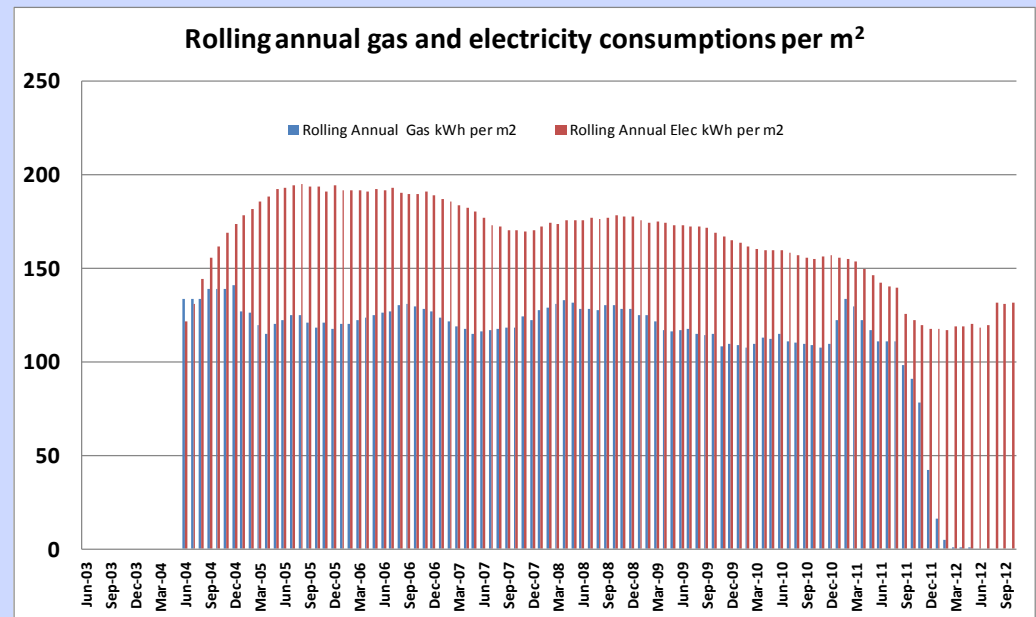

Reporting performance



- ➔ The following slides for McKenzie House (Cardiff University) illustrate the initial types of report which can be derived from the iSERVcmb system.
- ➔ Many more will be added over the next 6 months including:
 - Separate reports aimed at the occupants and services operators.
 - Cost-based reports aimed at finance managers
 - Carbon-based reports for compliance purposes
 - Reports aimed at the EPBD Inspection process needs

Building Level Report



- ➔ Overview of whole building performance against bespoke benchmarks predicted for mix of activities served.
- ➔ The bespoke benchmark ranges shown behind the actual energy consumption are derived from the whole building description
- ➔ So for its particular mix of activities and areas McKenzie House is in the upper quartile of achieved performance

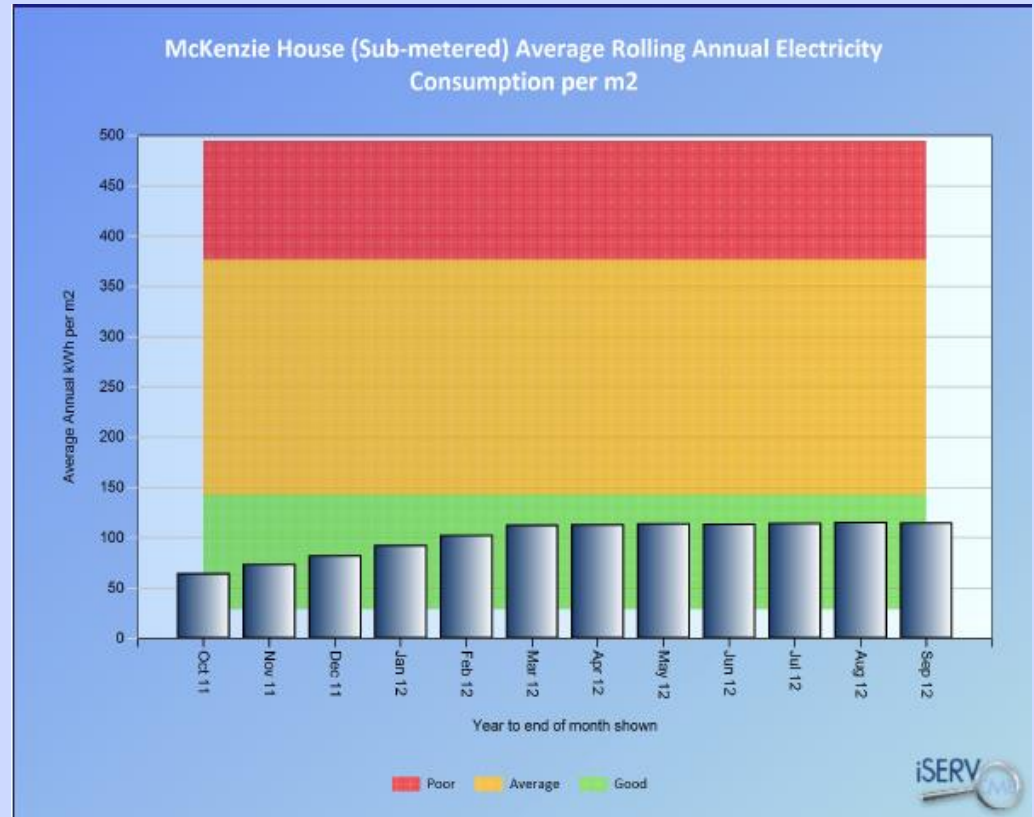

HVAC System Report



- ➔ Overview of whole HVAC system performance against bespoke benchmarks predicted for mix of activities served.
- ➔ Again note that only the areas and activities served by the HVAC system are used to set its benchmarks

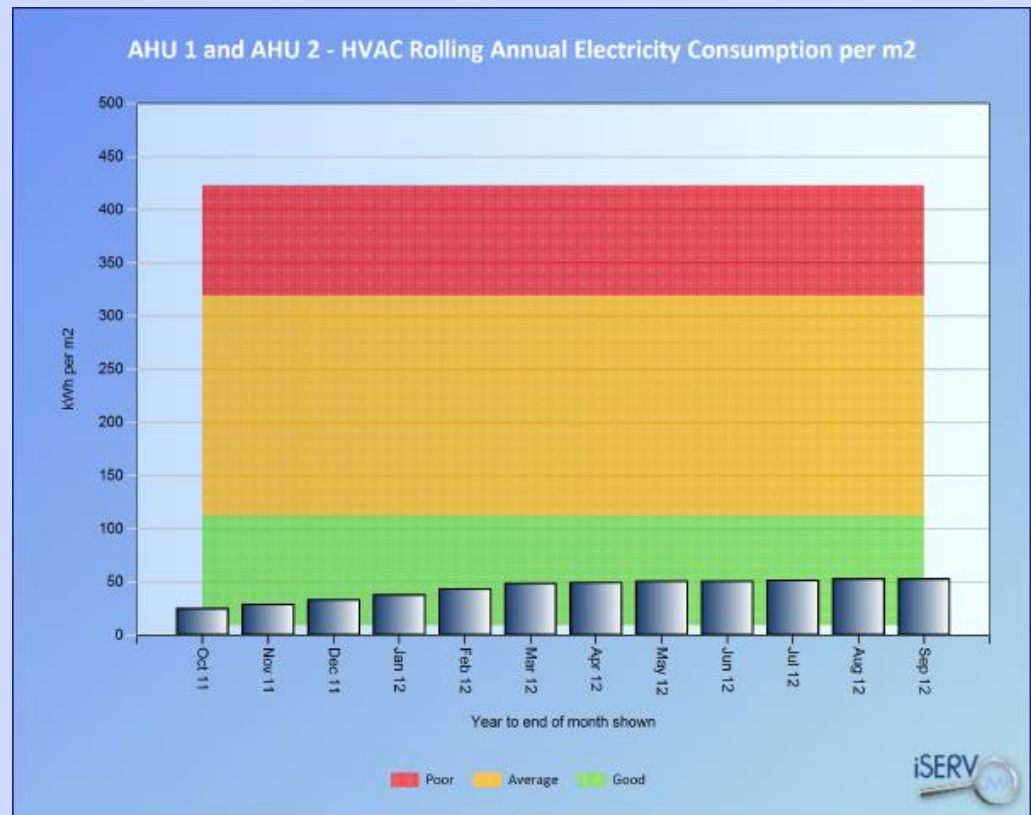

HVAC Component Report



➔ Overview of an HVAC component performance against its bespoke benchmarks predicted for the mix of activities and areas it serves.

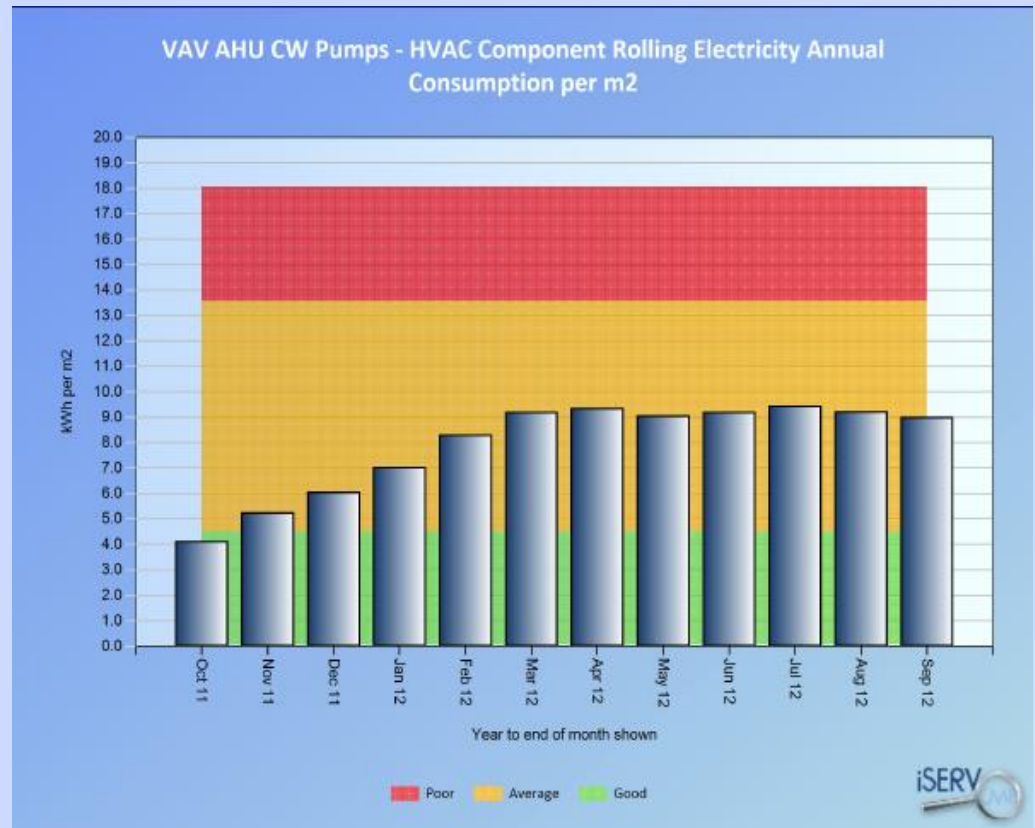

HVAC Component Reports



➔ Individual HVAC component normalised annual energy use against energy use ranges predicted by component for the mix of activities and areas served by that component

Component Level Electricity Consumption in kWh/m²/year against benchmark



Example outputs from iSERV data – subhourly data



➔ Example for Chiller 1 for July 2011 showing good time control compared to occupancy hours

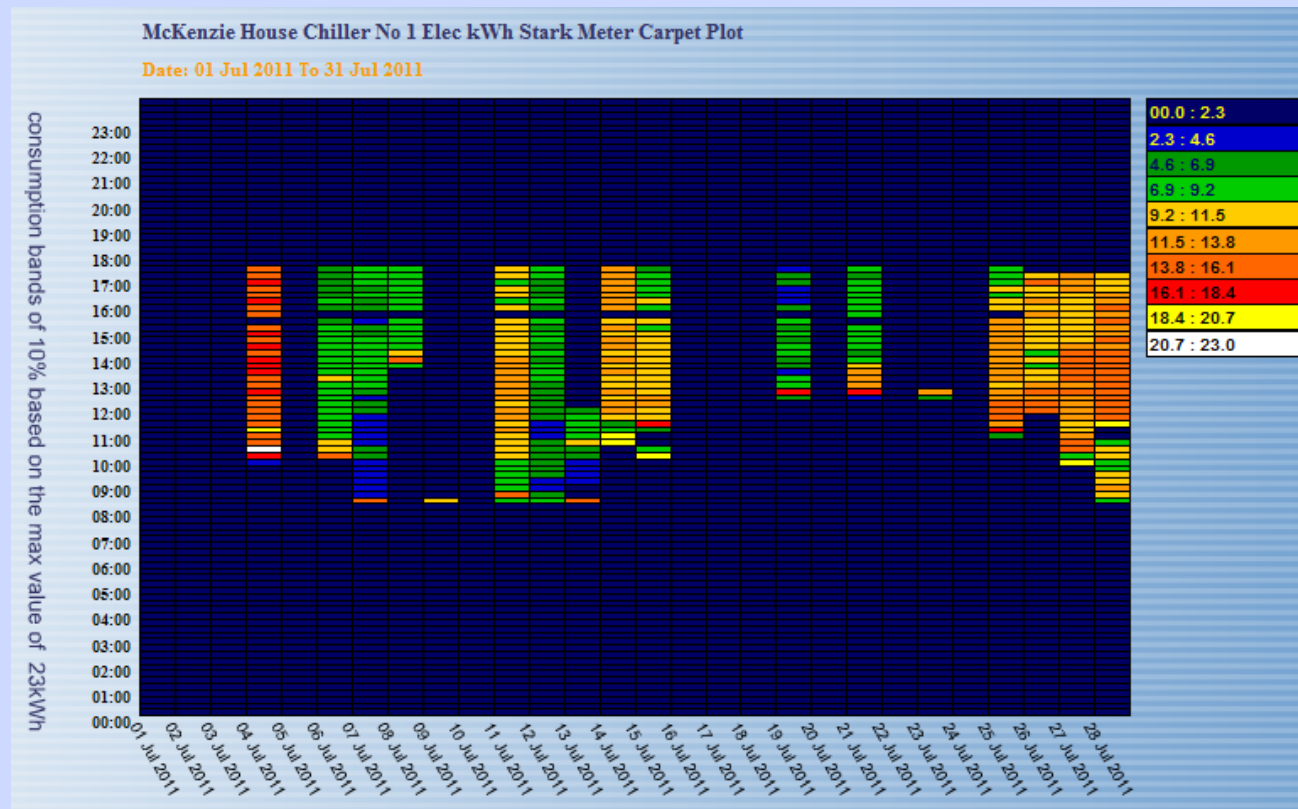

Energy use by component



- iSERV will calculate the consumption of individual HVAC components PER UNIT AREA SERVED where the component supply meter is recorded.
- This information is the basis of the on-going benchmarks to be produced by iSERV when combined with the activity(s) served

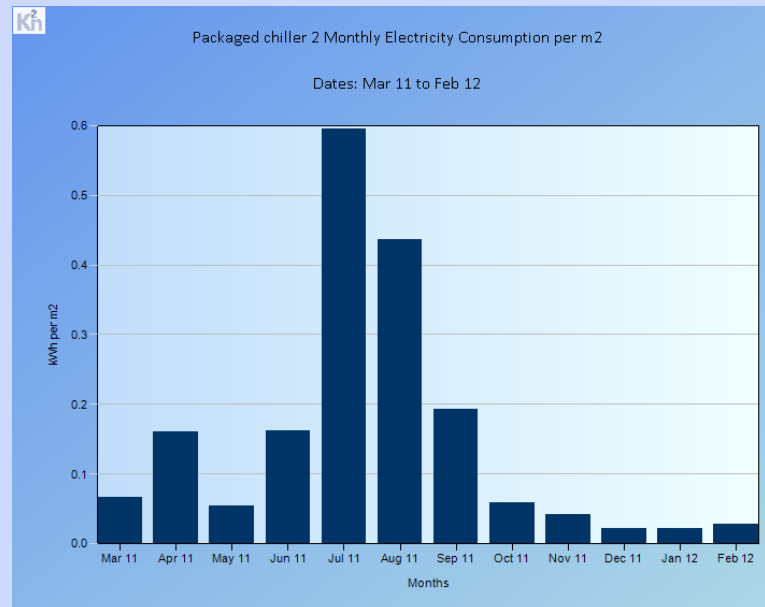

Energy cost by activity



- Energy cost by activity can be calculated for the whole building energy consumption (monthly cost shown here)
- This can also be broken down into HVAC and Occupant costs by activity per month
- The graph shows the small power and lighting costs in March 2012 for the activities undertaken in the building

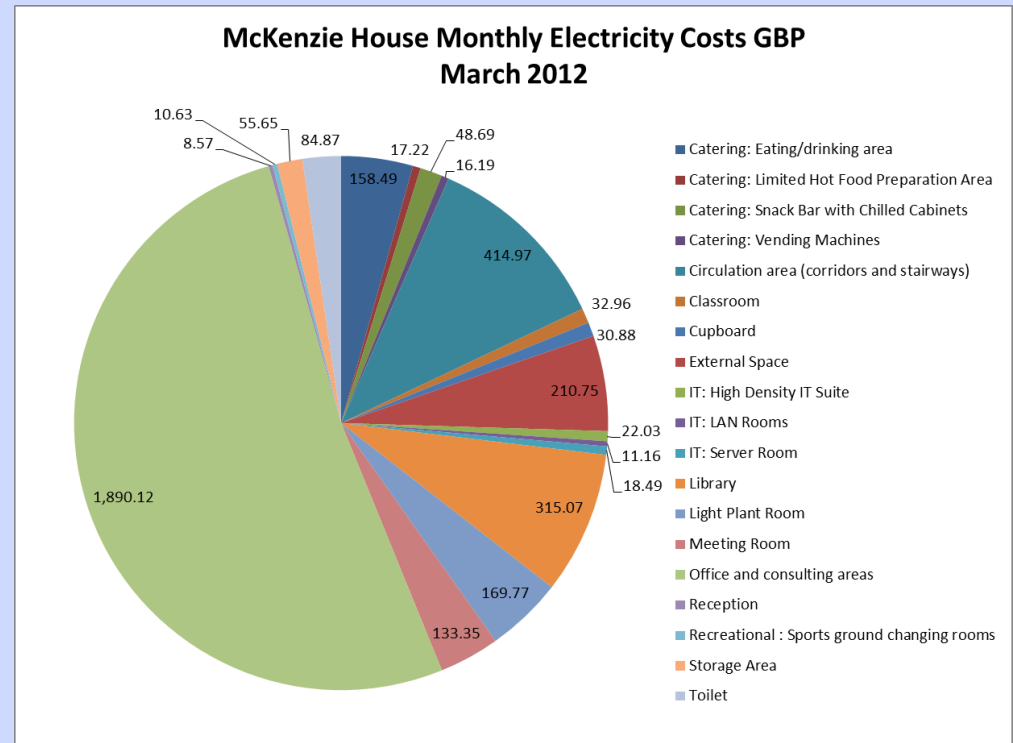

Energy cost by space



➔ These costs can be assigned by space as well based on the main activity in a space. Here TOTAL electricity costs are shown

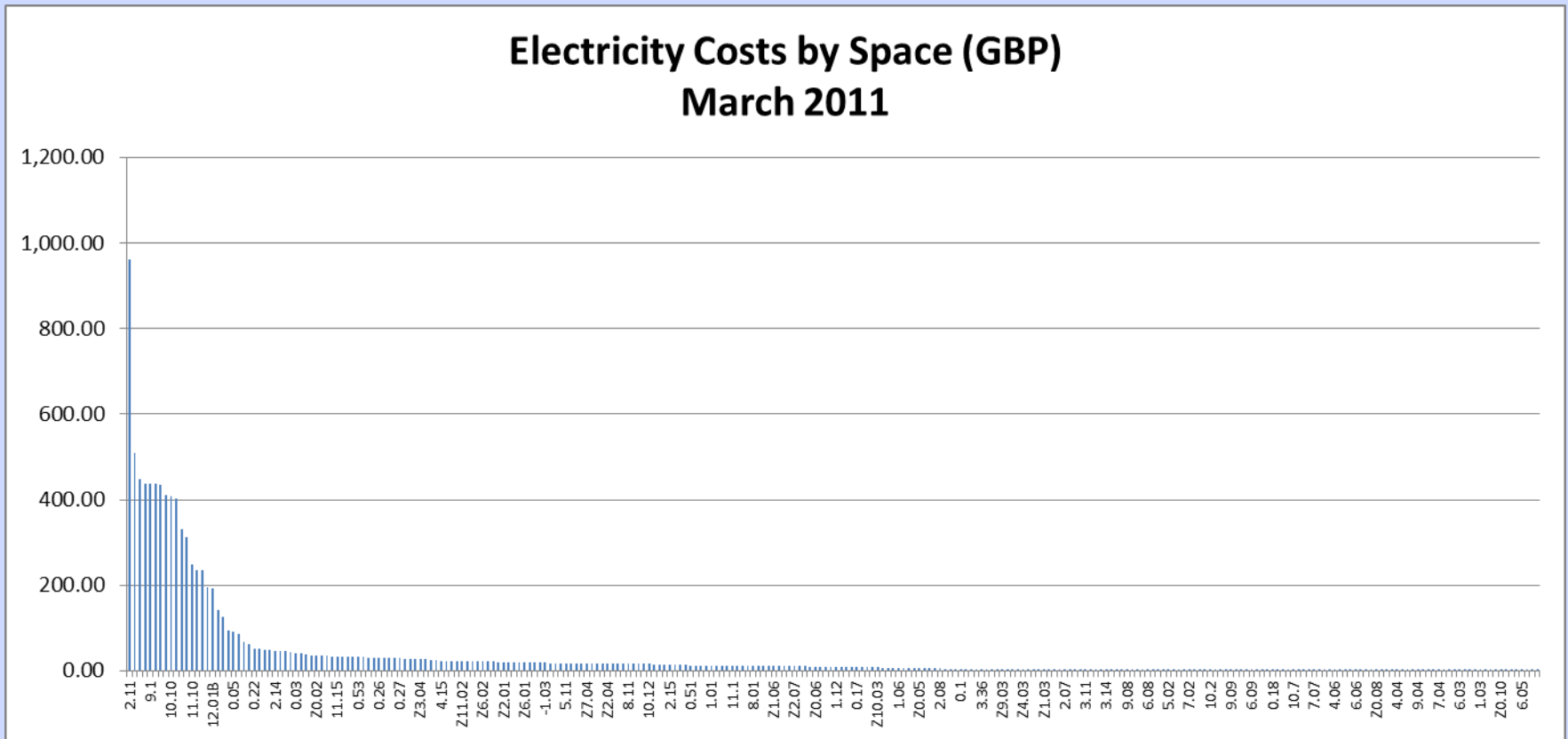

How to participate in iSERV



- ➔ Register on the iSERV website – www.iservcmb.info
- ➔ Notify the relevant iSERV Partner that you wish to participate, so that you have the latest information
- ➔ Download the iSERV spreadsheet and complete it for your HVAC system(s) by building.
- ➔ Validate the spreadsheet and send to iSERV for checking and entering to iSERV database
- ➔ Check and validate your data collection with iSERV
- ➔ Start using iSERV to help manage your HVAC system

iSERV – direct end user benefits



- ➔ Offers all HVAC system operators the opportunity to trial for free a monitoring and feedback approach to energy efficiency across their HVAC systems. iSERV:
- Will achieve usually substantial energy savings in participating systems
 - Deals with the data overload problem arising from trying to handle large quantities of metered data
 - Provides regular feedback to help maintain savings achieved
 - Provides analysis of monitored data and feedback on not only consumption achieved against benchmarks but also potential Energy Conservation Opportunities (ECOs).
 - Reduces staff time spent analysing data freeing it up for implementing practical energy conservation measures
 - Will put monetary figures to all this data where possible

iSERV – indirect end user benefits



- ➔ CIBSE and REHVA will publish benchmarks produced from iSERV as professional guidance i.e. the approach should become the accepted way to operate HVAC systems in practice across the EU. Participation therefore enables early experience to be gained
- ➔ Highlight participation as part of CSR with use of this logo on relevant company reports



- ➔ Help establish the principle that a demonstrably good energy consumption for an HVAC system should be acceptable as an alternative to prescriptive legislation – with Inspection only required where performance does not meet standards

iSERV Summary



- ➔ iSERV will produce 'benchmark' figures at HVAC component and activity level for the professions
- ➔ iSERV is the only large-scale 'open' approach to this area at present in Europe
- ➔ 'Blind' to manufacturer and other potential bias
- ➔ Allows rapid verification of novel HVAC approaches in real buildings
- ➔ Allows owners to fully understand their systems
- ➔ Essential for understanding HVAC system energy use in time to allow an orderly transition to nZEB

iSERV Summary (2)



- ➔ iSERV is working with the main actors across Europe to produce, evaluate and demonstrate a monitoring and feedback approach to reducing energy use in HVAC systems as now allowed by the EPBD
- ➔ All the indications to date are that the approach will produce significant energy savings as it clarifies and benchmarks an organisations activities and supporting services
- ➔ This provides confidence and a framework to evaluate and prioritise investment in energy efficiency by the end user
- ➔ The project will also provide benchmarks to which national legislation can refer for this type of approach



**Inspection of
HVAC systems
through
continuous
monitoring and
benchmarking**

www.iservcmb.info

Thank you for your attention

Dr Ian Knight

iSERV Coordinator

knight@cf.ac.uk

Dr Zoltan Magyar

iSERV WP8 leader

zmagyar@pmmik.ptt.hu

Dr Vincenc Butala

iSERV Slovenia

www.iservcmb.info